

AC and Pulse Film Foil Capacitors KP Radial Potted Type

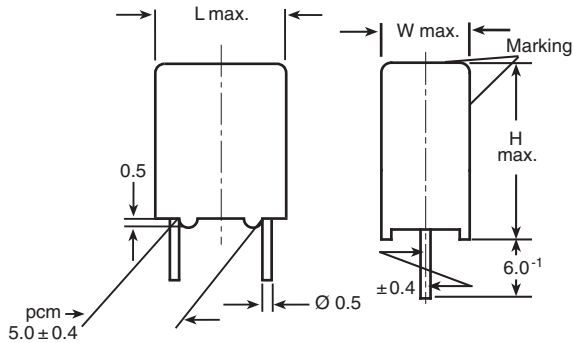

Dimensions in millimeters

MAIN APPLICATIONS

Oscillator, timing and LC/RC filter circuits, high frequency coupling of fast digital and analog IC's.

REFERENCE STANDARDS

IEC 60384-13

MARKING

C-value; tolerance; rated voltage; sub-class; manufacturer's type; code for dielectric material; manufacturer's location; manufacturer's logo; year and week

DIELECTRIC

Polypropylene film

ELECTRODES

Tin foil

CONSTRUCTION

Mono construction

RATED DC VOLTAGES

63 V, 250 V, 630 V

RATED AC VOLTAGES

40 V, 160 V, 250 V

FEATURES

- 5 mm lead pitch
- Supplied loose in box taped in ammpack or reel
- Material categorization: for definitions of compliance please see www.vishay.com/doc?99912



RoHS
COMPLIANT
HALOGEN
FREE

ENCAPSULATION

Plastic case, epoxy resin sealed, flame retardant UL-class 94 V-0

CLIMATIC TESTING CLASS ACCORDING TO IEC 60068-1

55/100/56

CAPACITANCE RANGE

100 pF to 0.022 µF

CAPACITANCE TOLERANCE

± 10 % , ± 5 % , ± 2.5 % , ± 2 % , ± 1 %

LEADS

Tinned wire

MAXIMUM APPLICATION TEMPERATURE

100 °C

DETAIL SPECIFICATION

For more detailed data and test requirements contact: dc-film@vishay.com

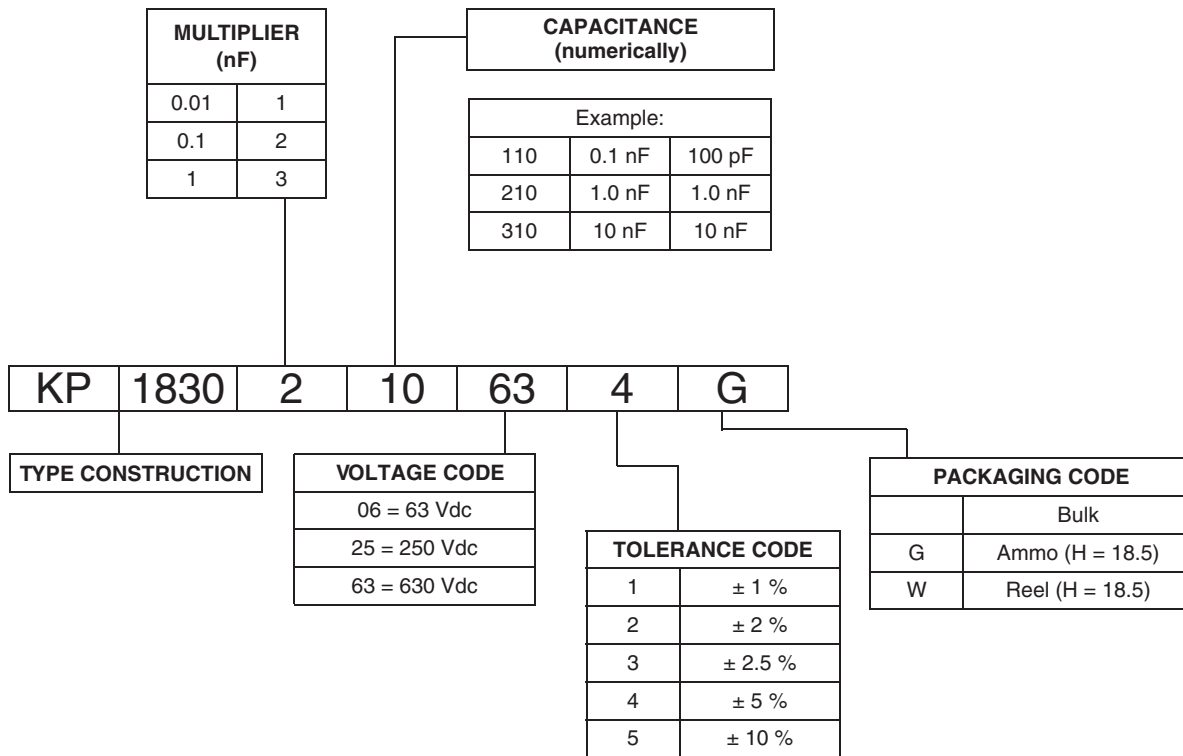
COMPOSITION OF CATALOG NUMBER

SPECIFIC REFERENCE DATA

| DESCRIPTION | VALUE | | | |
|--|--|---------------------|---------------------|---------------------|
| | at 1 kHz | at 10 kHz | at 100 kHz | at 1 MHz |
| Tangent of loss angle: | | | | |
| $C \leq 1000 \text{ pF}$ | - | 5×10^{-4} | - | 10×10^{-4} |
| $1000 \text{ pF} < C \leq 5000 \text{ pF}$ | - | 5×10^{-4} | 10×10^{-4} | - |
| $5000 \text{ pF} < C \leq 20\,000 \text{ pF}$ | - | 10×10^{-4} | 15×10^{-4} | - |
| $20\,000 \text{ pF} < C < 33\,000 \text{ pF}$ | - | 15×10^{-4} | 25×10^{-4} | - |
| Pitch (mm) | Maximum pulse rise time $(dU/dt)_R$ [V/ μ s] | | | |
| 5 | > 10 000 | | | |
| R between leads, for $C \leq 0.33 \text{ }\mu\text{F}$ at 100 V, 1 min | > 500 000 M Ω | | | |
| R between leads and case, 100 V, 1 min | > 30 000 M Ω | | | |
| Withstanding (DC) voltage (cut off current 10 mA), rise time 100 V/s | $1.6 \times U_{RDC}$, 1 min | | | |
| Withstanding (DC) voltage between leads and case | $2 \times U_{RDC}$, 1 min | | | |
| Maximum application temperature | 100 °C | | | |



| CAPACITANCE | CAPACITANCE CODE | VOLTAGE CODE 06 63 V _{DC} / 40 V _{AC} | | | VOLTAGE CODE 25 250 V _{DC} / 160 V _{AC} | | | VOLTAGE CODE 63 630 V _{DC} / 250 V _{AC} | | |
|-------------|------------------|--|--------|--------|--|--------|--------|--|--------|--------|
| | | W (mm) | H (mm) | L (mm) | W (mm) | H (mm) | L (mm) | W (mm) | H (mm) | L (mm) |
| 100 pF | -110 | - | - | - | - | - | - | 4.5 | 6.0 | 7.2 |
| 110 pF | -111 | - | - | - | - | - | - | 4.5 | 6.0 | 7.2 |
| 120 pF | -112 | - | - | - | - | - | - | 4.5 | 6.0 | 7.2 |
| 130 pF | -113 | - | - | - | - | - | - | 4.5 | 6.0 | 7.2 |
| 150 pF | -115 | - | - | - | - | - | - | 4.5 | 6.0 | 7.2 |
| 160 pF | -116 | - | - | - | - | - | - | 4.5 | 6.0 | 7.2 |
| 180 pF | -118 | - | - | - | - | - | - | 4.5 | 6.0 | 7.2 |
| 200 pF | -120 | - | - | - | - | - | - | 4.5 | 6.0 | 7.2 |
| 220 pF | -122 | - | - | - | - | - | - | 4.5 | 6.0 | 7.2 |
| 240 pF | -124 | - | - | - | - | - | - | 4.5 | 6.0 | 7.2 |
| 270 pF | -127 | - | - | - | - | - | - | 4.5 | 6.0 | 7.2 |
| 300 pF | -130 | - | - | - | - | - | - | 4.5 | 6.0 | 7.2 |
| 330 pF | -133 | - | - | - | - | - | - | 4.5 | 6.0 | 7.2 |
| 360 pF | -136 | - | - | - | - | - | - | 4.5 | 6.0 | 7.2 |
| 390 pF | -139 | - | - | - | - | - | - | 4.5 | 6.0 | 7.2 |
| 430 pF | -143 | - | - | - | - | - | - | 4.5 | 6.0 | 7.2 |
| 470 pF | -147 | - | - | - | - | - | - | 4.5 | 6.0 | 7.2 |
| 510 pF | -151 | - | - | - | - | - | - | 4.5 | 6.0 | 7.2 |
| 560 pF | -156 | - | - | - | - | - | - | 4.5 | 6.0 | 7.2 |
| 620 pF | -162 | - | - | - | - | - | - | 4.5 | 6.0 | 7.2 |
| 680 pF | -168 | - | - | - | - | - | - | 4.5 | 6.0 | 7.2 |
| 750 pF | -175 | - | - | - | - | - | - | 4.5 | 6.0 | 7.2 |
| 820 pF | -182 | - | - | - | - | - | - | 4.5 | 6.0 | 7.2 |
| 910 pF | -191 | - | - | - | - | - | - | 4.5 | 6.0 | 7.2 |
| 1000 pF | -210 | - | - | - | - | - | - | 4.5 | 6.0 | 7.2 |
| 1100 pF | -211 | - | - | - | - | - | - | 4.5 | 6.0 | 7.2 |
| 1200 pF | -212 | - | - | - | - | - | - | 4.5 | 6.0 | 7.2 |
| 1300 pF | -213 | - | - | - | - | - | - | 4.5 | 6.0 | 7.2 |
| 1500 pF | -215 | - | - | - | - | - | - | 4.5 | 6.0 | 7.2 |
| 1600 pF | -216 | - | - | - | - | - | - | 4.5 | 6.0 | 7.2 |
| 1800 pF | -218 | - | - | - | - | - | - | 4.5 | 6.0 | 7.2 |
| 2000 pF | -220 | - | - | - | 4.5 | 6.0 | 7.2 | 5.5 | 7.0 | 7.2 |
| 2200 pF | -222 | - | - | - | 4.5 | 6.0 | 7.2 | 5.5 | 7.0 | 7.2 |
| 2400 pF | -224 | 4.5 | 6.0 | 7.2 | 4.5 | 6.0 | 7.2 | 5.5 | 7.0 | 7.2 |
| 2700 pF | -227 | 4.5 | 6.0 | 7.2 | 4.5 | 6.0 | 7.2 | 5.5 | 7.0 | 7.2 |
| 3000 pF | -230 | 4.5 | 6.0 | 7.2 | 5.5 | 7.0 | 7.2 | 5.5 | 7.0 | 7.2 |
| 3300 pF | -233 | 4.5 | 6.0 | 7.2 | 5.5 | 7.0 | 7.2 | 5.5 | 7.0 | 7.2 |
| 3600 pF | -236 | 4.5 | 6.0 | 7.2 | 5.5 | 7.0 | 7.2 | 7.5 | 7.0 | 7.2 |
| 3900 pF | -239 | 4.5 | 6.0 | 7.2 | 5.5 | 7.0 | 7.2 | 7.5 | 9.0 | 7.2 |
| 4300 pF | -243 | 4.5 | 6.0 | 7.2 | 5.5 | 7.0 | 7.2 | 7.5 | 9.0 | 7.2 |
| 4700 pF | -247 | 4.5 | 6.0 | 7.2 | 5.5 | 7.0 | 7.2 | 7.5 | 9.0 | 7.2 |
| 5100 pF | -251 | 4.5 | 6.0 | 7.2 | 7.5 | 9.0 | 7.2 | 7.5 | 9.0 | 7.2 |
| 5600 pF | -256 | 4.5 | 6.0 | 7.2 | 7.5 | 9.0 | 7.2 | 7.5 | 9.0 | 7.2 |
| 6200 pF | -262 | 4.5 | 6.0 | 7.2 | 7.5 | 9.0 | 7.2 | 7.5 | 9.0 | 7.2 |
| 6800 pF | -268 | 4.5 | 6.0 | 7.2 | 7.5 | 9.0 | 7.2 | 7.5 | 9.0 | 7.2 |
| 7500 pF | -275 | 5.5 | 7.0 | 7.2 | 7.5 | 9.0 | 7.2 | 9.0 | 10.0 | 7.2 |
| 8200 pF | -282 | 5.5 | 7.0 | 7.2 | 7.5 | 9.0 | 7.2 | 9.0 | 10.0 | 7.2 |
| 9100 pF | -291 | 5.5 | 7.0 | 7.2 | 7.5 | 9.0 | 7.2 | 9.0 | 10.0 | 7.2 |
| 0.010 μF | -310 | 5.5 | 7.0 | 7.2 | 7.5 | 9.0 | 7.2 | 9.0 | 10.0 | 7.2 |
| 0.011 μF | -311 | 5.5 | 7.0 | 7.2 | 9.0 | 10.0 | 7.2 | - | - | - |
| 0.012 μF | -312 | 5.5 | 7.0 | 7.2 | 9.0 | 10.0 | 7.2 | - | - | - |
| 0.013 μF | -313 | 5.5 | 7.0 | 7.2 | 9.0 | 10.0 | 7.2 | - | - | - |
| 0.015 μF | -315 | 5.5 | 7.0 | 7.2 | 9.0 | 10.0 | 7.2 | - | - | - |
| 0.016 μF | -316 | 9.0 | 10.0 | 7.2 | - | - | - | - | - | - |
| 0.018 μF | -318 | 9.0 | 10.0 | 7.2 | - | - | - | - | - | - |
| 0.020 μF | -320 | 9.0 | 10.0 | 7.2 | - | - | - | - | - | - |
| 0.022 μF | -322 | 7.5 | 9.0 | 7.2 | - | - | - | - | - | - |

Note

- Further C-values upon request

RECOMMENDED PACKAGING

| LETTER CODE | TYPE OF PACKAGING | HEIGHT (H) (mm) | REEL DIAMETER (mm) | ORDERING CODE EXAMPLE | PITCH 5 |
|-------------|-------------------|-----------------|--------------------|-----------------------|---------|
| G | Ammo | 18.5 | S ⁽¹⁾ | KP1830-310-065-G | X |
| W | Reel | 18.5 | 350 | KP1830-310-065-W | X |
| - | Bulk | - | - | KP1830-310-065 | X |

Note

⁽¹⁾ S = box size 55 mm x 210 mm x 340 mm (W x H x L)

EXAMPLE OF ORDERING CODE

| TYPE | CAPACITANCE CODE | VOLTAGE CODE | TOLERANCE CODE | PACKAGING CODE |
|--------|------------------|--------------|----------------|----------------|
| KP1830 | 210 | 63 | 1 | G |

Tolerance codes: 1 = 1 % (F); 2 = 2 % (G); 3 = 2.5 % (H); 4 = 5 % (J); 5 = 10 % (K)

Note

- For detailed tape specifications refer to “Packaging Information” www.vishay.com/doc?28139 or end of catalog

MOUNTING
Normal Use

The capacitors are designed for mounting on printed-circuit boards. The capacitors packed in bandoliers are designed for mounting on printed-circuit boards by means of automatic insertion machines.

For detailed tape specifications refer to “Packaging information” www.vishay.com/doc?28139 or end of catalog

Specific Method of Mounting of Withstand Vibration and Shock

In order to withstand vibration and shock tests, it must be ensured that the stand-off pips are in good contact with the printed-circuit board.

- For pitches ≤ 15 mm the capacitors shall be mechanically fixed by the leads
- For larger pitches the capacitors shall be mounted in the same way and the body clamped

Space Requirements on Printed-Circuit Board

The maximum length and width of film capacitors is shown in the drawing:

- Eccentricity as in drawing. The maximum eccentricity is smaller than or equal to the lead diameter of the product concerned
- Product height with seating plane as given by “IEC 60717” as reference: $h_{max.} \leq h + 0.4$ mm or $h_{max.} \leq h' + 0.4$ mm

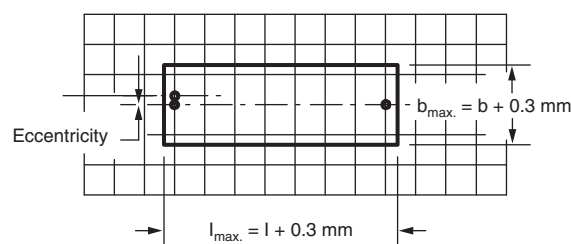
Storage Temperature

$T_{stg} = -25$ °C to $+35$ °C with RH maximum 75 % without condensation

Ratings and Characteristics Reference Conditions

Unless otherwise specified, all electrical values apply to an ambient free temperature of 23 °C ± 1 °C, an atmospheric pressure of 86 kPa to 106 kPa and a relative humidity of 50 % ± 2 %.

For reference testing, a conditioning period shall be applied over 96 h ± 4 h by heating the products in a circulating air oven at the rated temperature and a relative humidity not exceeding 20 %.



CHARACTERISTICS

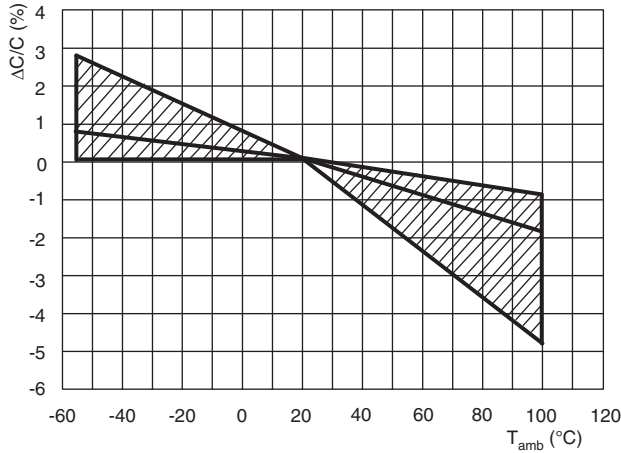

Capacitance as a function of ambient temperature (typical curve)

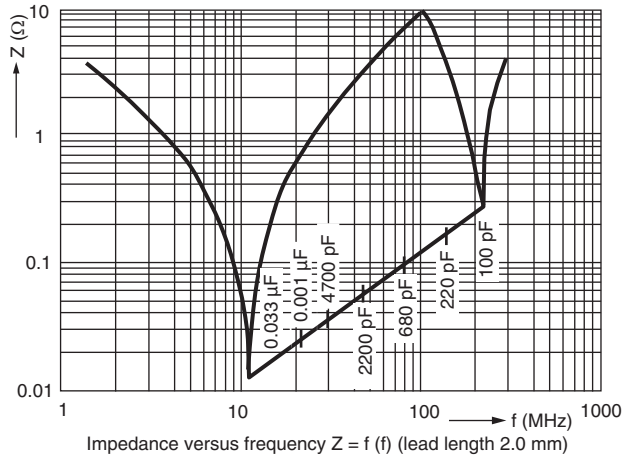

Impedance as a function of frequency (typical curve)

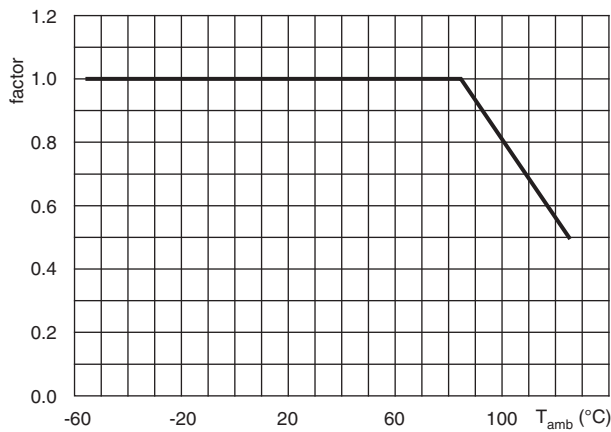

Maximum DC and AC voltage as a function of temperature

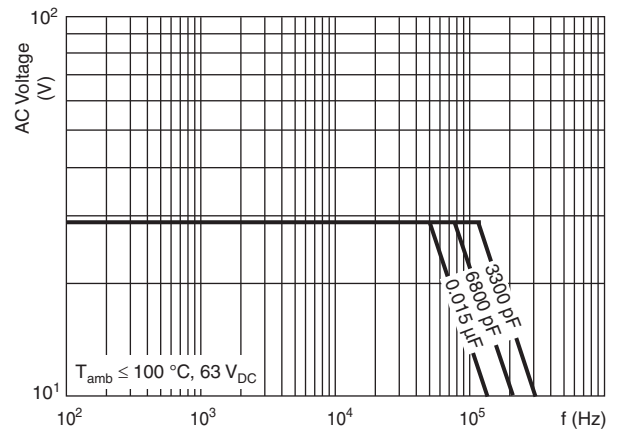

Maximum RMS voltage as a function of frequency

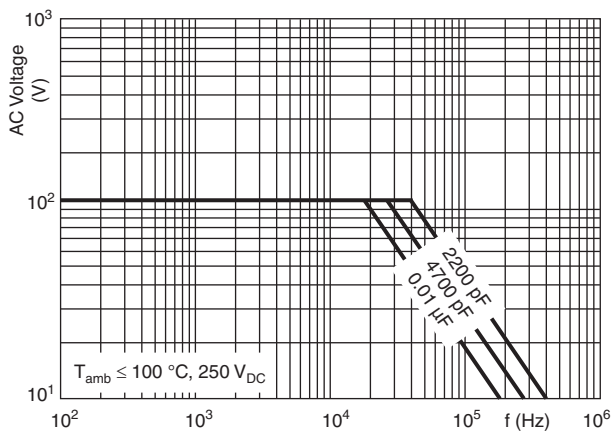

Maximum RMS voltage as a function of frequency

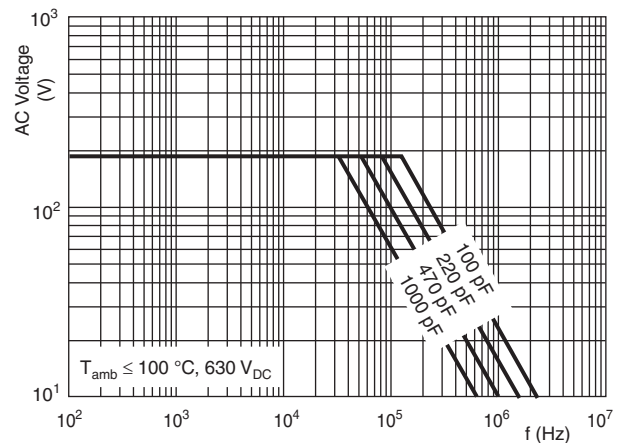

Maximum RMS voltage as a function of frequency

HEAT CONDUCTIVITY (G) AS A FUNCTION OF ORIGINAL PITCH AND CAPACITOR BODY THICKNESS IN mW/°C

| W _{max.} (mm) | HEAT CONDUCTIVITY (mW/°C) | |
|------------------------|---------------------------|--|
| | PITCH 5 mm | |
| 4.5 | 3 | |
| 5.5 | 4 | |
| 7.5 | 6 | |
| 9.0 | 7 | |

POWER DISSIPATION AND MAXIMUM COMPONENT TEMPERATURE RISE

The power dissipation must be limited in order not to exceed the maximum allowed component temperature rise as a function of the free air ambient temperature.

The power dissipation can be calculated according type detail specification “HQN-384-01/101: Technical Information Film Capacitors” with the typical t_{gd} of the curves.

The component temperature rise (ΔT) can be measured (see section “Measuring the component temperature” for more details) or calculated by $\Delta T = P/G$:

- ΔT = component temperature rise (°C)
- P = power dissipation of the component (mW)
- G = heat conductivity of the component (mW/°C)

MEASURING THE COMPONENT TEMPERATURE

A thermocouple must be attached to the capacitor body as in:

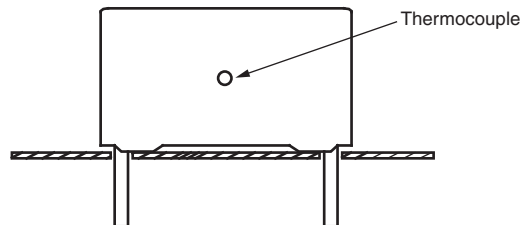

The temperature is measured in unloaded (T_{amb}) and maximum loaded condition (T_C).

The temperature rise is given by $\Delta T = T_C - T_{amb}$.

To avoid radiation or convection, the capacitor should be tested in a wind-free box.

APPLICATION NOTE AND LIMITING CONDITIONS

To select the capacitor for a certain application, the following conditions must be checked:

1. The peak voltage (U_p) shall not be greater than the rated DC voltage (U_{RDC}).
2. The peak-to-peak voltage (U_{p-p}) shall not be greater than the maximum (U_{p-p}) to avoid the ionization inception level.
3. The maximum component surface temperature rise must be lower than the limits.
4. The maximum application temperature must be lower than 105 °C.
5. There is no limit for the voltage pulse slope in the application.



INSPECTION REQUIREMENTS

General Notes

Sub-clause numbers of tests and performance requirements refer to the "Sectional Specification, Publication IEC 60384-13 and Specific Reference Data".

Group C Inspection Requirements

| SUB-CLAUSE NUMBER AND TEST | CONDITIONS | PERFORMANCE REQUIREMENTS |
|---|---|---|
| SUB-GROUP C1A PART OF SAMPLE OF SUB-GROUP C1 | | |
| 4.1 Dimensions (detail) | | As specified in chapters "General Data" of this specification |
| 4.3.1 Initial measurements | Capacitance at 1 kHz Tangent of loss angle at 100 kHz | |
| 4.3 Robustness of terminations | Tensile: load 10 N; 10 s Bending: load 5 N; 4 x 90° | No visible damage |
| 4.4 Resistance to soldering heat | No predrying Method: 1A Solder bath: 280 °C ± 5 °C Duration: 5 s | |
| 4.14 Component solvent resistance | Isopropylalcohol at room temperature Method: 2 Immersion time: 5.0 min ± 0.5 min Recovery time: min. 1 h, max. 2 h | |
| 4.4.2 Final measurements | Visual examination | No visible damage Legible marking |
| | Capacitance | $ \Delta C/C \leq 2\%$ of the value measured in 4.3.1 |
| SUB-GROUP C1B PART OF SAMPLE OF SUB-GROUP C1 | | |
| 4.6.1 Initial measurements | Capacitance at 1 kHz Tangent of loss angle at 100 kHz | |
| 4.14 Solvent resistance of the marking | Isopropylalcohol at room temperature Method: 1 Rubbing material: cotton wool Immersion time: 5.0 min ± 0.5 min | No visible damage Legible marking |
| 4.6 Rapid change of temperature | 0A = -55 °C 0B = +105 °C 5 cycles Duration t = 30 min | |
| 4.7 Vibration | Visual examination Mounting: See section "Mounting" of this specification Procedure B4 Frequency range: 10 Hz to 55 Hz Amplitude: 0.75 mm or Acceleration 98 m/s ² (whichever is less severe) Total duration 6 h | No visible damage |
| 4.7.2 Final inspection | Visual examination | No visible damage |
| | Capacitance | $ \Delta C/C \leq 2\%$ of the value measured in 4.6.1 |
| | Tangent of loss angle | As specified in section "Tangent of loss angle" of this specification |



| SUB-CLAUSE NUMBER AND TEST | CONDITIONS | PERFORMANCE REQUIREMENTS |
|--|---|---|
| 4.9 Shock | Mounting: See section "Mounting" of this specification Pulse shape: half sine Acceleration: 490 m/s ² Duration of pulse: 11 ms | |
| 4.9.3 Final measurements | Visual examination Capacitance | No visible damage $ \Delta C/C \leq 2\%$ of the value measured in 4.6.1. |
| SUB-GROUP C1 COMBINED SAMPLE OF SPECIMENS OF SUB-GROUPS C1A AND C1B | | |
| 4.10 Climatic sequence | | |
| 4.10.2 Dry heat | Temperature: +100 °C Duration: 16 h | |
| 4.10.3 Damp heat cyclic Test Db, first cycle | | |
| 4.10.4 Cold | Temperature: -55 °C Duration: 2 h | |
| 4.10.6 Damp heat cyclic Test Db, remaining cycles | Recovery 1 h to 2 h | |
| 4.10.6.2 Final measurements | Voltage proof = U_{RDC} for 1 min within 15 min after removal from testchamber Visual examination Capacitance Tangent of loss angle Insulation resistance | No breakdown or flash-over No visible damage Legible marking $ \Delta C/C \leq 2\%$ of the value measured in 4.10.2 As specified in section "Tangent of loss angle" of this specification or ≤ 1.4 times the value measured in 4.3.1 whichever is greater $\geq 50\%$ of values specified in section "Insulation resistance" of this specification |
| SUB-GROUP C2 | | |
| 4.11 Damp heat steady state | | |
| 4.11.1 Initial measurements | Capacitance at 1 kHz Tangent of loss angle at 1 kHz Voltage proof = U_{RDC} for 1 min within 15 min after removal from testchamber | No breakdown or flash-over |
| 4.11.3 Final measurements | Visual examination Capacitance Tangent of loss angle Insulation resistance | No visible damage Legible marking $ \Delta C/C \leq 1\%$ of the value measured in 4.11.1. As specified in section "Tangent of loss angle" of this specification or ≤ 1.4 times the value measured in 4.11.1 whichever is greater $\geq 50\%$ of values specified in section "Insulation resistance" of this specification |



| SUB-CLAUSE NUMBER AND TEST | CONDITIONS | PERFORMANCE REQUIREMENTS |
|-----------------------------|--|---|
| SUB GROUP C3 | | |
| 4.12 Endurance | Duration: 2000 h 1.5 x U _{RDC} at 85 °C 1.05 x U _{RDC} at 100 °C | |
| 4.12.1 Initial measurements | Capacitance at 1 kHz Tangent of loss angle at 100 kHz | |
| 4.12.5 Final measurements | Visual examination | No visible damage Legible marking |
| | Capacitance | $ \Delta C/C \leq 2\%$ of the value measured in 4.12.1 |
| | Tangent of loss angle | As specified in section "Tangent of loss angle" of this specification or ≤ 1.4 times the value measured in 4.12.1 whichever is greater |
| | Insulation resistance | As specified in section "Insulation resistance" of this specification |



Disclaimer

ALL PRODUCT, PRODUCT SPECIFICATIONS AND DATA ARE SUBJECT TO CHANGE WITHOUT NOTICE TO IMPROVE RELIABILITY, FUNCTION OR DESIGN OR OTHERWISE.

Vishay Intertechnology, Inc., its affiliates, agents, and employees, and all persons acting on its or their behalf (collectively, "Vishay"), disclaim any and all liability for any errors, inaccuracies or incompleteness contained in any datasheet or in any other disclosure relating to any product.

Vishay makes no warranty, representation or guarantee regarding the suitability of the products for any particular purpose or the continuing production of any product. To the maximum extent permitted by applicable law, Vishay disclaims (i) any and all liability arising out of the application or use of any product, (ii) any and all liability, including without limitation special, consequential or incidental damages, and (iii) any and all implied warranties, including warranties of fitness for particular purpose, non-infringement and merchantability.

Statements regarding the suitability of products for certain types of applications are based on Vishay's knowledge of typical requirements that are often placed on Vishay products in generic applications. Such statements are not binding statements about the suitability of products for a particular application. It is the customer's responsibility to validate that a particular product with the properties described in the product specification is suitable for use in a particular application. Parameters provided in datasheets and / or specifications may vary in different applications and performance may vary over time. All operating parameters, including typical parameters, must be validated for each customer application by the customer's technical experts. Product specifications do not expand or otherwise modify Vishay's terms and conditions of purchase, including but not limited to the warranty expressed therein.

Except as expressly indicated in writing, Vishay products are not designed for use in medical, life-saving, or life-sustaining applications or for any other application in which the failure of the Vishay product could result in personal injury or death. Customers using or selling Vishay products not expressly indicated for use in such applications do so at their own risk. Please contact authorized Vishay personnel to obtain written terms and conditions regarding products designed for such applications.

No license, express or implied, by estoppel or otherwise, to any intellectual property rights is granted by this document or by any conduct of Vishay. Product names and markings noted herein may be trademarks of their respective owners.