



Aluminum electrolytic capacitors

Capacitors with 4-pin snap-in terminals and solder pins

Series/Type: B43510, B43520

Date: November 2008

Long-life grade capacitors

Applications

- Frequency converters
- Switch-mode power supplies in industrial and consumer electronics
- Uninterruptible power supplies

Features

- Voltage derating ($0.88 \cdot V_R$) enables 105 °C operation, more details available upon request
- Extremely high volumetric efficiency
- High ripple current capability
- Many different case sizes
- Pinning ensures correct insertion
- RoHS-compatible

Construction

- Charge/discharge-proof, polar
- Aluminum case, fully insulated with PVC
- Version with additional PET insulation cap on terminal side available for insulating the capacitor from the PCB (B43510 only)
- Overload protection by safety vent in case

Terminals

- 4-pin snap-in terminals (6.3 mm and 4.5 mm length)
- Solder pin mounting on printed circuit boards, pins fit standardized spacings on PCB



B43510

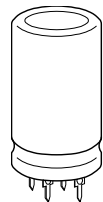

B43520

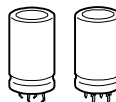
Specifications and characteristics in brief

Rated voltage V_R	385 ... 500 V DC															
Surge voltage V_S	$1.1 \cdot V_R$															
Rated capacitance C_R	390 ... 2700 μ F															
Capacitance tolerance	$\pm 20\% \triangle M$															
Leakage current I_{leak} (5 min, 20 °C)	$I_{leak} \leq 0.3 \mu A \cdot \left(\frac{C_R}{\mu F} \cdot \frac{V_R}{V} \right)^{0.7} + 4 \mu A$															
Self-inductance ESL	Approx. 20 nH															
Useful life 85 °C; V_R ; $I_{AC,R}$ 40 °C; V_R ; $1.1 \cdot I_{AC,R}$	> 5000 h > 250000 h	Requirements: $\Delta C/C \leq \pm 30\%$ of initial value ESR ≤ 3 times initial specified limit $I_{leak} \leq$ initial specified limit														
Voltage endurance test 85 °C; V_R	2000 h	Post test requirements: $\Delta C/C \leq \pm 10\%$ of initial value ESR ≤ 1.3 times initial specified limit $I_{leak} \leq$ initial specified limit														
Vibration resistance test	To IEC 60068-2-6, test Fc: Displacement amplitude 0.35 mm, frequency range 10 ... 55 Hz, acceleration max. 5 g, duration 3×2 h. Capacitor mounted by its body which is rigidly clamped to the work surface.															
Characteristics at low temperature	Max. impedance ratio at 100 Hz	<table border="1"> <thead> <tr> <th>V_R</th> <th>≤ 400 V</th> <th>420 ... 450 V</th> <th>500 V</th> </tr> </thead> <tbody> <tr> <td>$Z_{-25^\circ C} / Z_{20^\circ C}$</td> <td>4</td> <td>7</td> <td>7</td> </tr> <tr> <td>$Z_{-40^\circ C} / Z_{20^\circ C}$</td> <td>7</td> <td>14</td> <td>20</td> </tr> </tbody> </table>	V_R	≤ 400 V	420 ... 450 V	500 V	$Z_{-25^\circ C} / Z_{20^\circ C}$	4	7	7	$Z_{-40^\circ C} / Z_{20^\circ C}$	7	14	20		
V_R	≤ 400 V	420 ... 450 V	500 V													
$Z_{-25^\circ C} / Z_{20^\circ C}$	4	7	7													
$Z_{-40^\circ C} / Z_{20^\circ C}$	7	14	20													
IEC climatic category	To IEC 60068-1: $V_R \leq 400$ V DC: 40/085/56 (–40 °C/+85 °C/56 days damp heat test) $V_R > 400$ V DC: 25/085/56 (–25 °C/+85 °C/56 days damp heat test) The capacitors can be operated in the temperature range of –40 °C to +85 °C but the impedance at –40 °C should be taken into consideration.															
Detail specification	Similar to CECC 30301-805															
Sectional specification	IEC 60384-4															



B43510, B43520

Compact – 85 °C

Dimensional drawings

B43510, 4-pin snap-in terminals, PVC insulation

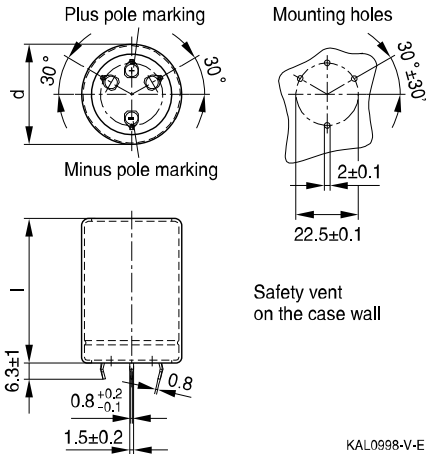

Dimensions (mm)		Approx. weight (g)	Packing units (pcs.)
d +1	l ±2		
35	50	63	60
35	60	76	36
35	70	88	36
35	80	101	36
35	100	126	36
40	50	89	33
40	60	107	33
40	70	125	33
40	80	143	33
40	100	178	33
45	50	113	28
45	60	136	28
45	70	158	28
45	80	181	28
45	100	226	28

Standard snap-in terminals:

length (6.3 ±1) mm.

Also available with length of (4.5 –1) mm.

All pin holes must be drilled into the PC-board, since the unconnected pins serve as mountings. These pins must be soldered to isolated pads or pads with the same potential as the negative pole.

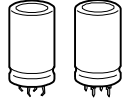
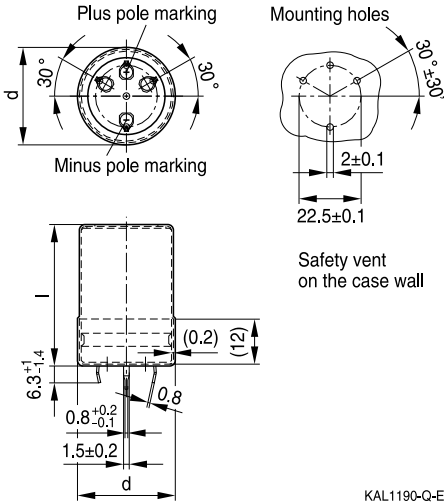
B43510, 4-pin snap-in terminals, PVC insulation and PET insulation cap on terminal side

Dimensions (mm)		Approx. weight (g)	Packing units (pcs.)
d +1.4	l +2.2/-2		
35	50	63	60
35	60	76	36
35	70	88	36
35	80	101	36
35	100	126	36
40	50	89	33
40	60	107	33
40	70	125	33
40	80	143	33
40	100	178	33
45	50	113	28
45	60	136	28
45	70	158	28
45	80	181	28
45	100	226	28

Standard snap-in terminals: length 6.3 +1/-1.4 mm. Also available with length of 4.5 – 1.4 mm. PET insulation cap is positioned under the insulation sleeve.

All pin holes must be drilled into the PC-board, since the unconnected pins serve as mountings. These pins must be soldered to isolated pads or pads with the same potential as the negative pole.

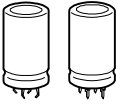

B43510, B43520

Compact – 85 °C

B43520, solder pins

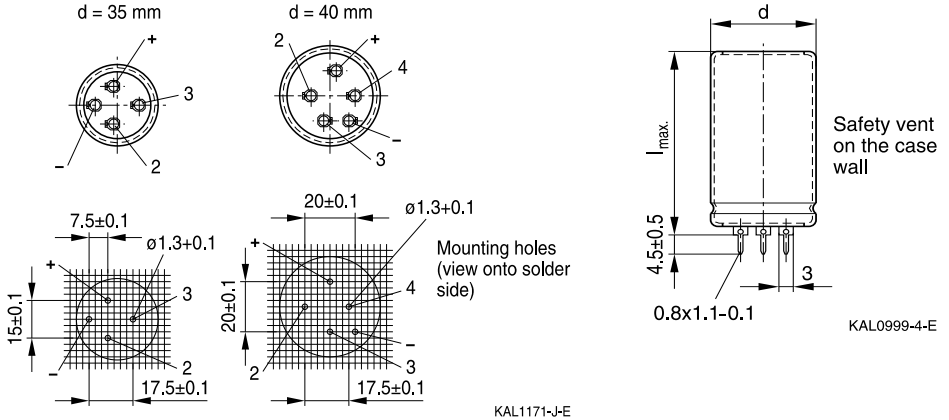

Pole markings: Plus: +; Minus: –

All pin holes must be drilled into the PC-board, since the unconnected pins serve as mountings. These pins should be soldered to isolated pads or pads with the same potential as the negative pole.

Dimensions (mm)		Approx. weight (g)	Packing units (pcs.)
d +1	l_{max}		
35	54	63	60
35	64	76	36
35	74	88	36
35	84	101	36
35	104	126	36
40	54	89	33
40	64	107	33
40	74	125	33
40	84	143	33
40	104	178	33

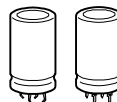

Packing of 4-pin snap-in terminal and solder pin capacitors



For ecological reasons the packing is pure cardboard.

Ordering codes for terminal styles and insulation features

Identification in 3rd block of ordering code

4-pin snap-in terminal capacitors

Terminal version	Insulation version	
	PVC	PVC plus PET cap
Standard terminals 6.3 mm	M000	M080
Short terminals 4.5 mm	M007	M087

Ordering examples:

- B43510A9188M007 } 4-pin snap-in capacitor with short terminals and standard PVC insulation
- B43510A9188M080 } 4-pin snap-in capacitor with standard terminals and PVC insulation with additional PET insulation cap on terminal side

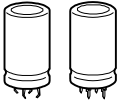

B43510, B43520
Compact – 85 °C
Overview of available types

V_R (V DC)	385	400	420	450	500
	Case dimensions $d \times l$ (mm)				
C_R (μF)					
390					35 × 60
470					35 × 70
560				35 × 60	35 × 70 40 × 60
680	35 × 50 40 × 50	35 × 60 40 × 50	35 × 60 40 × 50	35 × 70 40 × 50	35 × 100 40 × 70
820	35 × 60 40 × 50	35 × 60 40 × 50	35 × 70 40 × 60	35 × 80 40 × 60	35 × 100 40 × 80
1000	35 × 70 40 × 60	35 × 70 40 × 60 45 × 50	35 × 80 40 × 60	35 × 100 40 × 70 45 × 60	40 × 100 45 × 70
1200	35 × 80 40 × 70	35 × 100 40 × 70	40 × 70	40 × 80 45 × 70	45 × 100
1500	40 × 80 45 × 60	35 × 100 40 × 80 45 × 70	40 × 100 45 × 70	40 × 100 45 × 80	45 × 100
1800	40 × 100 45 × 70	40 × 100 45 × 80	40 × 100 45 × 80	45 × 100	
2200	40 × 100	45 × 100		45 × 100	
2700	45 × 100	45 × 100			

The capacitance and voltage ratings listed above are available in different cases upon request.

Other voltage and capacitance ratings are also available upon request.

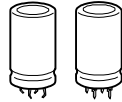
Capacitors with solder pins are only available in 35 and 40 mm case diameters.

Technical data and ordering codes

C_R	Case dimensions	ESR _{typ} 100 Hz 20 °C μF	ESR _{max} 100 Hz 20 °C mΩ	Z _{max} 10 kHz 20 °C mΩ	I _{AC,max} 100 Hz 60 °C A	I _{AC,R} 100 Hz 85 °C A	Ordering code (composition see below)
V_R = 385 V DC							
680	35 × 50	140	190	150	6.8	3.5	B435*0A3687M0##
680	40 × 50	140	190	150	7.2	3.7	B435*0B3687M0##
820	35 × 60	110	160	130	8.0	4.1	B435*0A3827M0##
820	40 × 50	110	160	130	7.9	4.0	B435*0B3827M0##
1000	35 × 70	90	130	110	9.4	4.8	B435*0A3108M0##
1000	40 × 60	90	130	110	9.3	4.8	B435*0B3108M0##
1200	35 × 80	80	110	90	10.9	5.6	B435*0A3128M0##
1200	40 × 70	80	110	90	10.8	5.5	B435*0B3128M0##
1500	40 × 80	60	90	70	12.7	6.5	B435*0A3158M0##
1500	45 × 60	60	90	70	11.4	5.9	B43510B3158M0##
1800	40 × 100	50	80	60	15.3	7.8	B435*0A3188M0##
1800	45 × 70	50	80	60	13.3	6.8	B43510B3188M0##
2200	40 × 100	50	60	50	16.9	8.7	B435*0A3228M0##
2700	45 × 100	40	50	40	18.7	9.6	B43510A3278M0##
V_R = 400 V DC							
680	35 × 60	140	190	150	7.3	3.7	B435*0A9687M0##
680	40 × 50	140	190	150	7.2	3.7	B435*0B9687M0##
820	35 × 60	110	160	130	8.0	4.1	B435*0A9827M0##
820	40 × 50	110	160	130	7.9	4.0	B435*0B9827M0##
1000	35 × 70	90	130	110	9.4	4.8	B435*0A9108M0##
1000	40 × 60	90	130	110	9.3	4.8	B435*0B9108M0##
1000	45 × 50	90	130	110	8.7	4.5	B43510C9108M0##
1200	35 × 100	80	110	90	11.9	6.1	B435*0A9128M0##
1200	40 × 70	80	110	90	10.8	5.5	B435*0B9128M0##
1500	35 × 100	60	90	70	13.4	6.8	B435*0A9158M0##

Capacitors with solder pins are only available in 35 and 40 mm case diameters.

Composition of ordering code

* = Terminal type

1 = 4-pin snap-in terminals

2 = solder pin

= Terminal style and insulation feature

00 = solder pin or 4-pin snap-in standard terminals and PVC insulation

07 = 4-pin snap-in short terminals and PVC insulation

80 = 4-pin snap-in standard terminals and PVC insulation with additional PET insulation cap on terminal side

87 = 4-pin snap-in short terminals and PVC insulation with additional PET insulation cap on terminal side

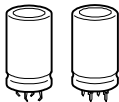

B43510, B43520

Compact – 85 °C

Technical data and ordering codes

C_R 100 Hz 20 °C μF	Case dimensions $d \times l$ mm	ESR_{typ} 100 Hz 20 °C m Ω	ESR_{max} 100 Hz 20 °C m Ω	Z_{max} 10 kHz 20 °C m Ω	$I_{\text{AC,max}}$ 100 Hz 60 °C A	$I_{\text{AC,R}}$ 100 Hz 85 °C A	Ordering code (composition see below)
$V_R = 400 \text{ V DC}$							
1500	40 × 80	60	90	70	12.7	6.5	B435*0B9158M0##
1500	45 × 70	60	90	70	12.1	6.2	B43510C9158M0##
1800	40 × 100	50	80	60	15.3	7.8	B435*0A9188M0##
1800	45 × 80	50	80	60	14.0	7.2	B43510B9188M0##
2200	45 × 100	50	60	50	16.9	8.6	B43510A9228M0##
2700	45 × 100	40	50	40	18.7	9.6	B43510A9278M0##
$V_R = 420 \text{ V DC}$							
680	35 × 60	230	300	240	7.3	3.7	B435*0A0687M0##
680	40 × 50	230	300	240	7.2	3.7	B435*0B0687M0##
820	35 × 70	190	250	200	8.5	4.4	B435*0A0827M0##
820	40 × 60	190	250	200	8.4	4.3	B435*0B0827M0##
1000	35 × 80	160	200	160	9.9	5.1	B435*0A0108M0##
1000	40 × 60	160	200	160	9.3	4.8	B435*0B0108M0##
1200	40 × 70	130	170	140	10.8	5.5	B435*0A0128M0##
1500	40 × 100	110	140	110	14.0	7.2	B435*0A0158M0##
1500	45 × 70	110	140	110	12.1	6.2	B43510B0158M0##
1800	40 × 100	90	120	90	15.3	7.8	B435*0A0188M0##
1800	45 × 80	90	120	90	14.0	7.2	B43510B0188M0##
$V_R = 450 \text{ V DC}$							
560	35 × 60	270	360	290	6.6	3.4	B435*0A5567M0##
680	35 × 70	230	300	240	7.7	4.0	B435*0A5687M0##
680	40 × 50	230	300	240	7.2	3.7	B435*0B5687M0##
820	35 × 80	190	250	200	9.0	4.6	B435*0A5827M0##
820	40 × 60	190	250	200	8.4	4.3	B435*0B5827M0##
1000	35 × 100	160	200	160	10.9	5.6	B435*0A5108M0##

Capacitors with solder pins are only available in 35 and 40 mm case diameters.

Composition of ordering code

* = Terminal type

1 = 4-pin snap-in terminals

2 = solder pin

= Terminal style and insulation feature

00 = solder pin or 4-pin snap-in standard terminals and PVC insulation

07 = 4-pin snap-in short terminals and PVC insulation

80 = 4-pin snap-in standard terminals and PVC insulation with additional PET insulation cap on terminal side

87 = 4-pin snap-in short terminals and PVC insulation with additional PET insulation cap on terminal side

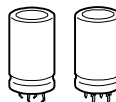
Technical data and ordering codes

C_R	Case dimensions	ESR_{typ}	ESR_{max}	Z_{max}	$I_{AC,max}$	$I_{AC,R}$	Ordering code (composition see below)
100 Hz	$d \times l$	100 Hz	100 Hz	10 kHz	100 Hz	100 Hz	
20 °C	mm	20 °C	20 °C	20 °C	60 °C	85 °C	
μF		m Ω	m Ω	m Ω	A	A	
$V_R = 450$ V DC							
1000	40 × 70	160	200	160	9.9	5.1	B435*0B5108M0##
1000	45 × 60	160	200	160	9.3	4.8	B43510C5108M0##
1200	40 × 80	130	170	140	11.4	5.8	B435*0A5128M0##
1200	45 × 70	130	170	140	10.8	5.5	B43510B5128M0##
1500	40 × 100	110	140	110	14.0	7.2	B435*0A5158M0##
1500	45 × 80	110	140	110	12.7	6.5	B43510B5158M0##
1800	45 × 100	90	120	90	15.3	7.8	B43510A5188M0##
2200	45 × 100	70	100	80	16.9	8.6	B43510A5228M0##
$V_R = 500$ V DC							
390	35 × 60	390	520	410	3.6	1.9	B435*0A6397M0##
470	35 × 70	320	430	340	4.2	2.2	B435*0A6477M0##
560	35 × 70	270	360	290	4.6	2.4	B435*0A6567M0##
560	40 × 60	270	360	290	4.5	2.3	B435*0B6567M0##
680	35 × 100	230	300	240	5.9	3.0	B435*0A6687M0##
680	40 × 70	230	300	240	5.3	2.7	B435*0B6687M0##
820	35 × 100	190	250	200	6.4	3.3	B435*0A6827M0##
820	40 × 80	190	250	200	6.1	3.2	B435*0B6827M0##
1000	40 × 100	160	200	160	7.4	3.8	B435*0A6108M0##
1000	45 × 70	160	200	160	6.4	3.3	B43510B6108M0##
1200	45 × 100	130	170	140	8.1	4.2	B43510A6128M0##
1500	45 × 100	110	140	110	9.1	4.7	B43510A6158M0##

Capacitors with solder pins are only available in 35 and 40 mm case diameters.

Composition of ordering code

* = Terminal type

1 = 4-pin snap-in terminals

2 = solder pin

= Terminal style and insulation feature

00 = solder pin or 4-pin snap-in standard terminals and PVC insulation

07 = 4-pin snap-in short terminals and PVC insulation

80 = 4-pin snap-in standard terminals and PVC insulation with additional PET insulation cap on terminal side

87 = 4-pin snap-in short terminals and PVC insulation with additional PET insulation cap on terminal side

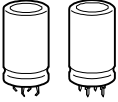

B43510, B43520

Compact – 85 °C

Useful life

depending on ambient temperature T_A under ripple current operating conditions¹⁾
 Voltage derating ($0.88 \cdot V_R$) enables 105 °C operation

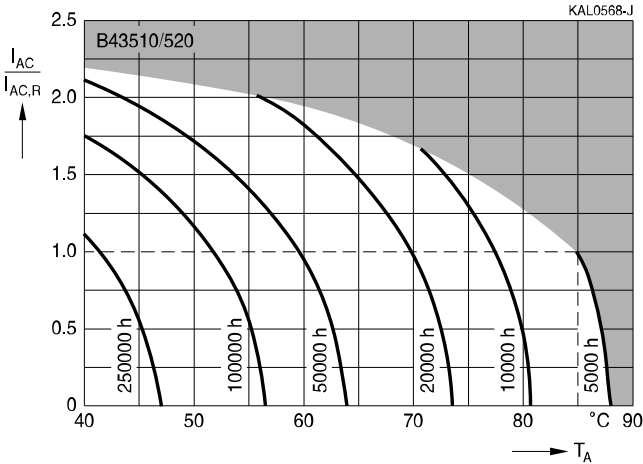

Frequency factor of permissible ripple current I_{AC} versus frequency f

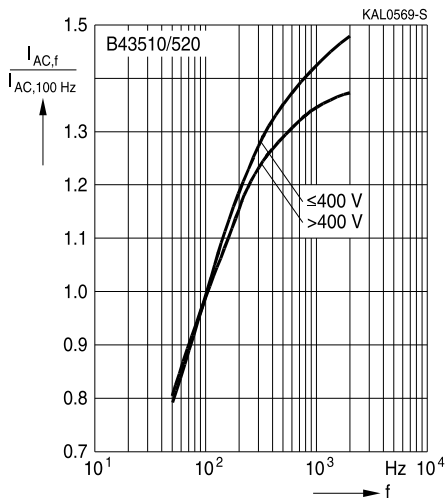

Frequency characteristics of ESR

Typical behavior

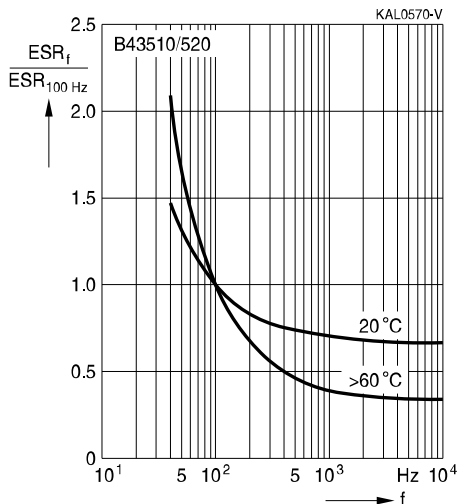

1) Refer to chapter "General technical information, 5.3 Calculation of useful life" on how to interpret the useful life graphs.

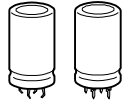

Impedance Z versus frequency f

Typical behavior at 20 °C

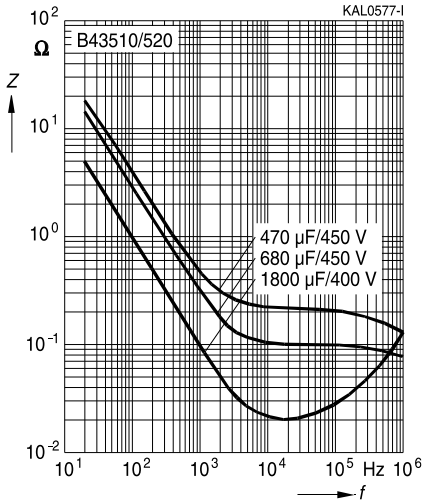

**B43510, B43520****Compact – 85 °C**

Cautions and warnings

Personal safety

The electrolytes used by EPCOS have not only been optimized with a view to the intended application, but also with regard to health and environmental compatibility. They do not contain any solvents that are detrimental to health, e.g. dimethyl formamide (DMF) or dimethyl acetamide (DMAC).

Furthermore, part of the high-voltage electrolytes used by EPCOS are self-extinguishing. They contain flame-retarding substances which will quickly extinguish any flame that may have been ignited.

As far as possible, EPCOS does not use any dangerous chemicals or compounds to produce operating electrolytes. However, in exceptional cases, such materials must be used in order to achieve specific physical and electrical properties because no safe substitute materials are currently known. However, the amount of dangerous materials used in our products has been limited to an absolute minimum. Nevertheless, the following rules should be observed when handling Al electrolytic capacitors:

- Any escaping electrolyte should not come into contact with eyes or skin.
- If electrolyte does come into contact with the skin, wash the affected parts immediately with running water. If the eyes are affected, rinse them for 10 minutes with plenty of water. If symptoms persist, seek medical treatment.
- Avoid breathing in electrolyte vapor or mists. Workplaces and other affected areas should be well ventilated. Clothing that has been contaminated by electrolyte must be changed and rinsed in water.

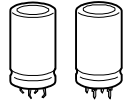

Product safety

The table below summarize the safety instructions that must be observed without fail. A detailed description can be found in the relevant sections of chapter "General technical information".

Topic	Safety information	Reference Chapter "General technical information"
Polarity	Make sure that polar capacitors are connected with the right polarity.	1 "Basic construction of aluminum electrolytic capacitors"
Reverse voltage	Voltages polarity classes should be prevented by connecting a diode.	3.1.6 "Reverse voltage"
Upper category temperature	Do not exceed the upper category temperatur.	7.2 "Maximum permissible operating temperature"
Maintenance	Make periodic inspections of the capacitors. Before the inspection, make sure that the power supply is turned off and carefully discharge the electricity of the capacitors. Do not apply any mechanical stress to the capacitor terminals.	10 "Maintenance"
Mounting position of screw terminal capacitors	Do not mount the capacitor with the terminals (safety vent) upside down.	11.1. "Mounting positions of capacitors with screw terminals"
Mounting of single-ended capacitors	The internal structure of single-ended capacitors might be damaged if excessive force is applied to the lead wires. Avoid any compressive, tensile or flexural stress. Do not move the capacitor after soldering to PC board. Do not pick up the PC board by the soldered capacitor. Do not insert the capacitor on the PC board with a hole space different to the lead space specified.	11.4 "Mounting considerations for single-ended capacitors"
Robustness of terminals	The following maximum tightening torques must not be exceeded when connecting screw terminals: M5: 2 Nm M6: 2.5 Nm	11.3 "Mounting torques"
Soldering	Do not exceed the specified time or temperature limits during soldering.	11.5 "Soldering"

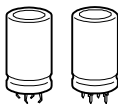

B43510, B43520

Compact – 85 °C

Topic	Safety information	Reference Chapter "General technical information"
Soldering, cleaning agents	Do not allow halogenated hydrocarbons to come into contact with aluminum electrolytic capacitors.	11.6 "Cleaning agents"
Passive flammability	Avoid external energy, such as fire or electricity.	8.1 "Passive flammability"
Active flammability	Avoid overload of the capacitors.	8.2 "Active flammability"
		Reference Chapter "Capacitors with screw terminals"
Breakdown strength of insulating sleeves	Do not damage the insulating sleeve, especially when ring clips are used for mounting.	"Screw terminals - accessories"

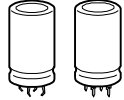
Symbols and terms

Symbol	English	German
C	Capacitance	Kapazität
C_R	Rated capacitance	Nennkapazität
C_S	Series capacitance	Serienkapazität
$C_{S,T}$	Series capacitance at temperature T	Serienkapazität bei Temperatur T
C_f	Capacitance at frequency f	Kapazität bei Frequenz f
d	Case diameter, nominal dimension	Gehäusedurchmesser, Nennmaß
d_{max}	Maximum case diameter	Maximaler Gehäusedurchmesser
ESL	Self-inductance	Eigeninduktivität
ESR	Equivalent series resistance	Ersatzserienwiderstand
ESR_f	Equivalent series resistance at frequency f	Ersatzserienwiderstand bei Frequenz f
ESR_T	Equivalent series resistance at temperature T	Ersatzserienwiderstand bei Temperatur T
f	Frequency	Frequenz
I	Current	Strom
I_{AC}	Alternating current (ripple current)	Wechselstrom
$I_{AC,rms}$	Root-mean-square value of alternating current	Wechselstrom, Effektivwert
$I_{AC,f}$	Ripple current at frequency f	Wechselstrom bei Frequenz f
$I_{AC,max}$	Maximum permissible ripple current	Maximal zulässiger Wechselstrom
$I_{AC,R}$	Rated ripple current	Nennwechselstrom
$I_{AC,R} (B)$	Rated ripple current for base cooling	Nennwechselstromstrom für Bodenkühlung
I_{leak}	Leakage current	Ableitstrom
$I_{leak,op}$	Operating leakage current	Ableitstrom bei Betrieb
l	Case length, nominal dimension	Gehäuselänge, Nennmaß
l_{max}	Maximum case length (without terminals and mounting stud)	Maximale Gehäuselänge (ohne Anschlüsse und Gewindebolzen)
R	Resistance	Widerstand
R_{ins}	Insulation resistance	Isolationswiderstand
R_{symm}	Balancing resistance	Symmetrierwiderstand
T	Temperature	Temperatur
ΔT	Temperature difference	Temperaturdifferenz
T_A	Ambient temperature	Umgebungstemperatur
T_C	Case temperature	Gehäusetemperatur
T_B	Capacitor base temperature	Temperatur des Becherbodens
t	Time	Zeit
Δt	Period	Zeitraum
t_b	Service life (operating hours)	Brauchbarkeitsdauer (Betriebszeit)

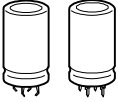
B43510, B43520
Compact – 85 °C

Symbol	English	German
V	Voltage	Spannung
V _F	Forming voltage	Formierspannung
V _{op}	Operating voltage	Betriebsspannung
V _R	Rated voltage, DC voltage	Nennspannung, Gleichspannung
V _S	Surge voltage	Spitzenspannung
X _C	Capacitive reactance	Kapazitiver Blindwiderstand
X _L	Inductive reactance	Induktiver Blindwiderstand
Z	Impedance	Scheinwiderstand
Z _T	Impedance at temperature T	Scheinwiderstand bei Temperatur T
tan δ	Dissipation factor	Verlustfaktor
λ	Failure rate	Ausfallrate
ε ₀	Absolute permittivity	Elektrische Feldkonstante
ε _r	Relative permittivity	Dielektrizitätszahl
ω	Angular velocity; $2 \cdot \pi \cdot f$	Kreisfrequenz; $2 \cdot \pi \cdot f$

Notes

All dimensions are given in mm.

Important notes

The following applies to all products named in this publication:

1. Some parts of this publication contain **statements about the suitability of our products for certain areas of application**. These statements are based on our knowledge of typical requirements that are often placed on our products in the areas of application concerned. We nevertheless expressly point out **that such statements cannot be regarded as binding statements about the suitability of our products for a particular customer application**. As a rule, EPCOS is either unfamiliar with individual customer applications or less familiar with them than the customers themselves. For these reasons, it is always ultimately incumbent on the customer to check and decide whether an EPCOS product with the properties described in the product specification is suitable for use in a particular customer application.
2. We also point out that **in individual cases, a malfunction of electronic components or failure before the end of their usual service life cannot be completely ruled out in the current state of the art, even if they are operated as specified**. In customer applications requiring a very high level of operational safety and especially in customer applications in which the malfunction or failure of an electronic component could endanger human life or health (e.g. in accident prevention or lifesaving systems), it must therefore be ensured by means of suitable design of the customer application or other action taken by the customer (e.g. installation of protective circuitry or redundancy) that no injury or damage is sustained by third parties in the event of malfunction or failure of an electronic component.
3. **The warnings, cautions and product-specific notes must be observed.**
4. In order to satisfy certain technical requirements, **some of the products described in this publication may contain substances subject to restrictions in certain jurisdictions (e.g. because they are classed as hazardous)**. Useful information on this will be found in our Material Data Sheets on the Internet (www.epcos.com/material). Should you have any more detailed questions, please contact our sales offices.
5. We constantly strive to improve our products. Consequently, **the products described in this publication may change from time to time**. The same is true of the corresponding product specifications. Please check therefore to what extent product descriptions and specifications contained in this publication are still applicable before or when you place an order. We also **reserve the right to discontinue production and delivery of products**. Consequently, we cannot guarantee that all products named in this publication will always be available. The aforementioned does not apply in the case of individual agreements deviating from the foregoing for customer-specific products.
6. Unless otherwise agreed in individual contracts, **all orders are subject to the current version of the "General Terms of Delivery for Products and Services in the Electrical Industry" published by the German Electrical and Electronics Industry Association (ZVEI)**.
7. The trade names EPCOS, BAOKE, Alu-X, CeraDiode, CSSP, CTVS, DSSP, MiniBlue, MKK, MLSC, MotorCap, PCC, PhaseCap, PhaseMod, SIFERRIT, SIFI, SIKOREL, SilverCap, SIMDAD, SIMID, SineFormer, SIOV, SIP5D, SIP5K, ThermoFuse, WindCap are **trademarks registered or pending** in Europe and in other countries. Further information will be found on the Internet at www.epcos.com/trademarks.