

### Pxxx0ME 5kA SIDACtor Series® in TO-218

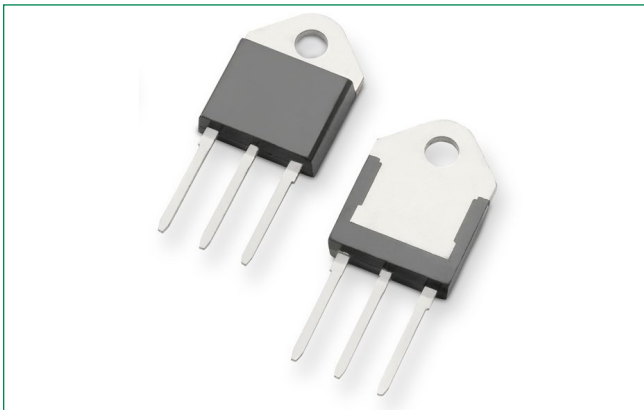

#### Agency Approvals

Agency	Agency File Number
	E133083

#### Pinout Designation

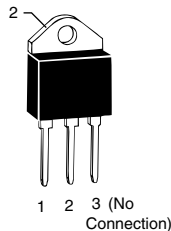

#### Schematic Symbol



#### Description

The 5kA series SIDACtor® components are designed to protect equipment located in high exposure environments from severe overvoltage transients.

Setup in a robust TO-218 package, the 5kA series are ideal for use in data interface and AC power line for CATV amplifiers, Telecom Base Station equipment and Cell Towers.

#### Features and Benefits

- Low voltage overshoot
- Low on-state voltage
- Does not degrade surge capability after multiple surge events within limit.
- Fails short circuit when surged in excess of rating
- Rugged TO-218 package
- 5000A 8/20  $\mu$ s surge rating
- Pb-free E3 means 2<sup>nd</sup> level interconnect is Pb-free and the terminal finish material is tin(Sn) (IPC/JEDEC J-STD-609A.01)
- RoHS compliant, lead-free and halogen-free

#### Applicable Global Standards

- TIA-968-A
- TIA-968-B
- ITU K.20/21/45 Enhanced Level
- ITU K.20/21/45 Basic Level
- GR 1089 Intra-building
- IEC 61000-4-5 2<sup>nd</sup> Edition
- YD/T 1082
- YD/T 993
- YD/T 950
- GR 1089 Inter-building

#### Electrical Characteristics

Part Number	Marking	$V_{DRM}$ @ $I_{DRM} = 5\mu A$	$V_S$ @ 100V/ $\mu s$	$I_H$	$I_S$	$I_T$	$V_T$ @ $I_T = 2.2 A$	Capacitance @ 1MHz, 2V bias	
		V min	V max	mA min	mA max	A max	V max	pF min	pF max
P1500MEL	P1500ME	140	180	50	800	2.2/25	4	400	650
P1900MEL	P1900ME	155	220	50	800	2.2/25	4	400	650
P2300MEL	P2300ME	180	260	50	800	2.2/25	4	350	600
P3800MEL	P3800ME	350	430	50	800	2.2/25	4	300	500
P4800MEL	P4800ME	450	600	20	800	2.2/25	4	300	500

#### Notes:

- Absolute maximum ratings measured at  $T_A = 25^\circ C$  (unless otherwise noted).
- Components are bi-directional (unless otherwise noted).
- $I_T$  is a free air rating and heat sink is at 25A

**Surge Ratings**

Series	$I_{PP}$			$I_{TSM}$ 50 / 60 Hz	di/dt
	1.2/50 <sup>1</sup> 8/20 <sup>2</sup>	10/350 <sup>1</sup> 1.2/50 <sup>2</sup>	10/1000 <sup>1</sup> 10/1000 <sup>2</sup>		
	A min	A min	A min		
E	5000 <sup>3</sup>	1500	1100	400	630

Notes:

- 1 Voltage waveform in  $\mu s$
  - 2 Current waveform in  $\mu s$
  3. For surge rating of P3800MEL, it is minimum 4kA and typical 5kA @8/20 $\mu s$ .
- Peak pulse current rating ( $I_{pp}$ ) is repetitive and guaranteed for the life of the product.
  - The component must initially be in thermal equilibrium with  $-40^{\circ}C \leq T_j \leq +150^{\circ}C$

**Thermal Conditions**

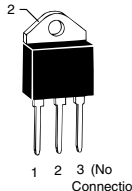
Package	Symbol	Parameter	Value	Unit
TO-218 	$T_{j0}$	Operating Junction Temperature Range	-40 to +150	$^{\circ}C$
	$T_s$	Storage Temperature Range	-65 to +150	$^{\circ}C$
	$T_c$	Maximum Case Temperature	100	$^{\circ}C$
	$R_{\theta JC}^*$	Thermal Resistance: Junction to Case	1.7	$^{\circ}C/W$
	$R_{\theta JA}$	Thermal Resistance: Junction to Ambient	56	$^{\circ}C/W$

\* $R_{\theta JC}$  rating assumes the use of a heat sink and on state mode for extended time at 25 A, with average power dissipation of 29.125 W.

**V-I Characteristics**

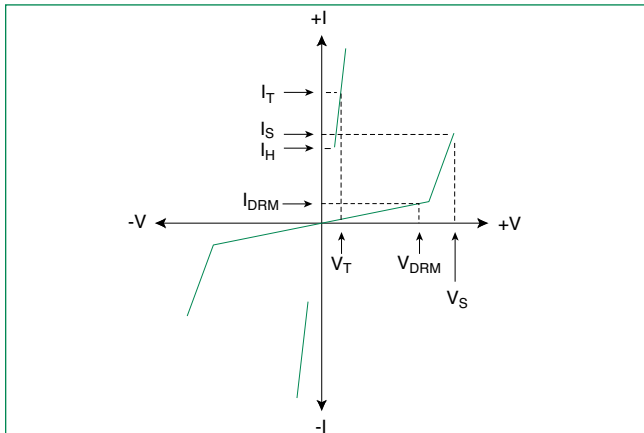

**$t_r \times t_d$  Pulse Waveform**

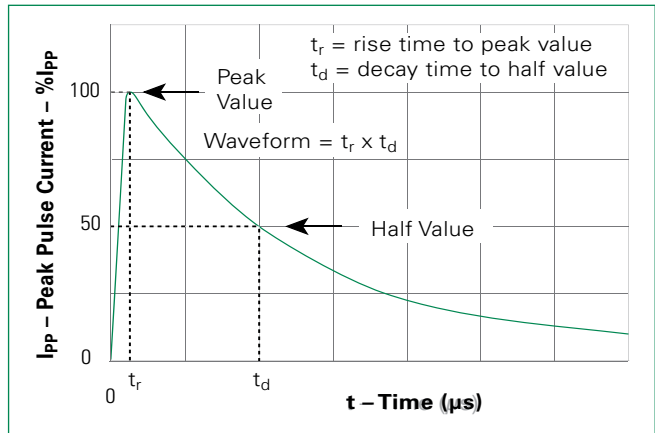

**Normalized  $V_s$  Change vs. Junction Temperature**

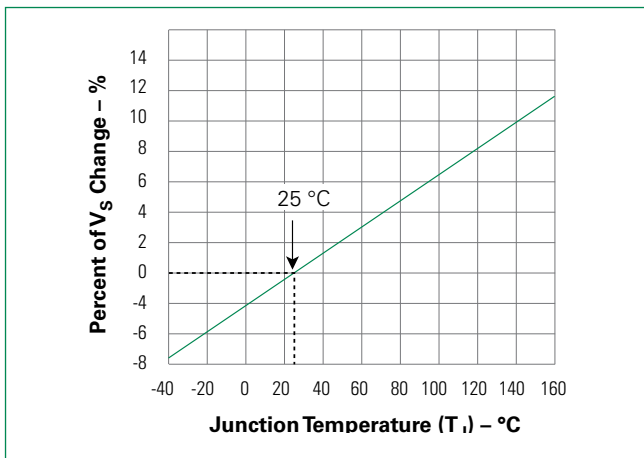

**Normalized DC Holding Current vs. Case Temperature**

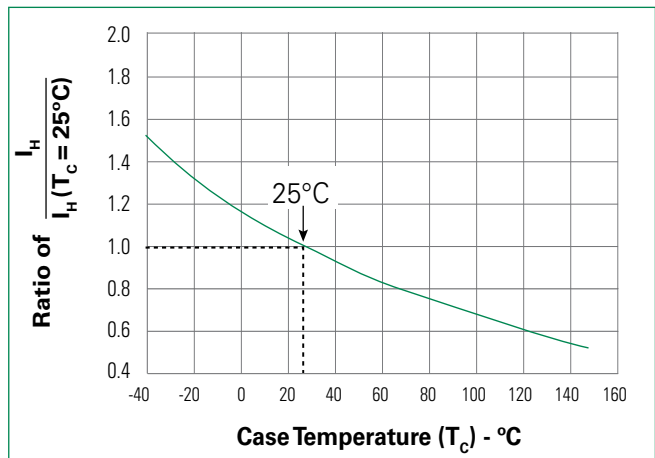

**Soldering Parameters**

<b>Reflow Condition</b>		Pb-Free assembly (see Fig. 1)
<b>Pre Heat</b>	- Temperature Min ( $T_{s(min)}$ )	+150°C
	- Temperature Max ( $T_{s(max)}$ )	+200°C
	- Time (Min to Max) ( $t_s$ )	60-180 secs.
<b>Average ramp up rate (Liquidus Temp (<math>T_L</math>) to peak)</b>		3°C/sec. Max.
<b><math>T_{s(max)}</math> to <math>T_L</math> - Ramp-up Rate</b>		3°C/sec. Max.
<b>Reflow</b>	- Temperature ( $T_L$ ) (Liquidus)	+217°C
	- Temperature ( $t_L$ )	60-150 secs.
<b>Peak Temp (<math>T_p</math>)</b>		+260(+0/-5)°C
<b>Time within 5°C of actual Peak Temp (<math>t_p</math>)</b>		30 secs. Max.
<b>Ramp-down Rate</b>		6°C/sec. Max.
<b>Time 25°C to Peak Temp (<math>T_p</math>)</b>		8 min. Max.
<b>Do not exceed</b>		+260°C

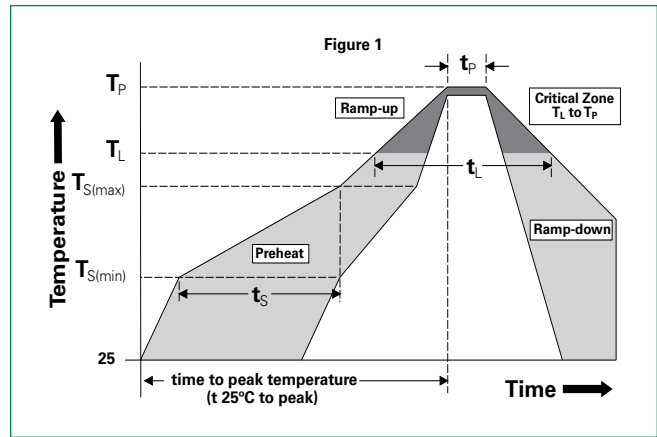

**Physical Specifications**

<b>Lead Material</b>	Copper Alloy
<b>Terminal Finish</b>	100% Matte-Tin Plated
<b>Body Material</b>	UL recognized epoxy meeting flammability classification V-0

**Environmental Specifications**

<b>High Temp Voltage Blocking</b>	80% Rated $V_{DRM}$ ( $V_{AC}$ Peak) +125°C or +150°C, 504 or 1008 hrs. MIL-STD-750 (Method 1040) JEDEC, JESD22-A-101
<b>Temp Cycling</b>	-65°C to +150°C, 15 min. dwell, 10 up to 100 cycles. MIL-STD-750 (Method 1051) EIA/JEDEC, JESD22-A104
<b>Biased Temp &amp; Humidity</b>	52 $V_{DC}$ (+85°C) 85%RH, 504 up to 1008 hrs. EIA/JEDEC, JESD22-A-101
<b>High Temp Storage</b>	+150°C 1008 hrs. MIL-STD-750 (Method 1031) JEDEC, JESD22-A-101
<b>Low Temp Storage</b>	-65°C, 1008 hrs.
<b>Thermal Shock</b>	0°C to +100°C, 5 min. dwell, 10 sec. transfer, 10 cycles. MIL-STD-750 (Method 1056) JEDEC, JESD22-A-106
<b>Autoclave (Pressure Cooker Test)</b>	+121°C, 100%RH, 2atm, 24 up to 168 hrs. EIA/JEDEC, JESD22-A-102
<b>Resistance to Solder Heat</b>	+260°C, 30 secs. MIL-STD-750 (Method 2031)
<b>Moisture Sensitivity Level</b>	85%RH, +85°C, 168 hrs., 3 reflow cycles (+260°C Peak). JEDEC-J-STD-020, Level 1

**Part Numbering**

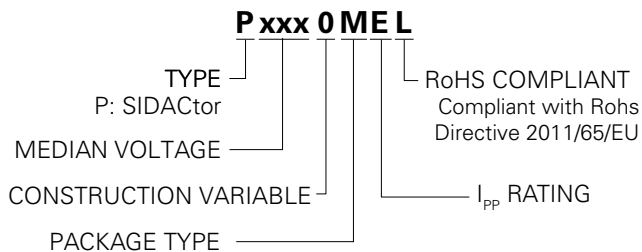

**Part Marking**

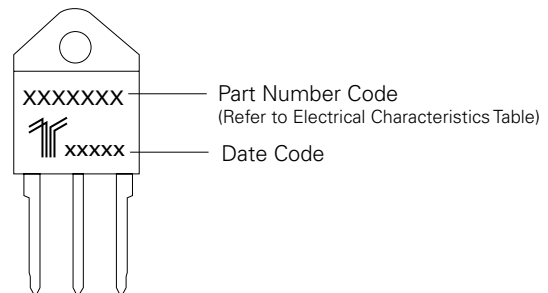

**Dimensions — TO-218**

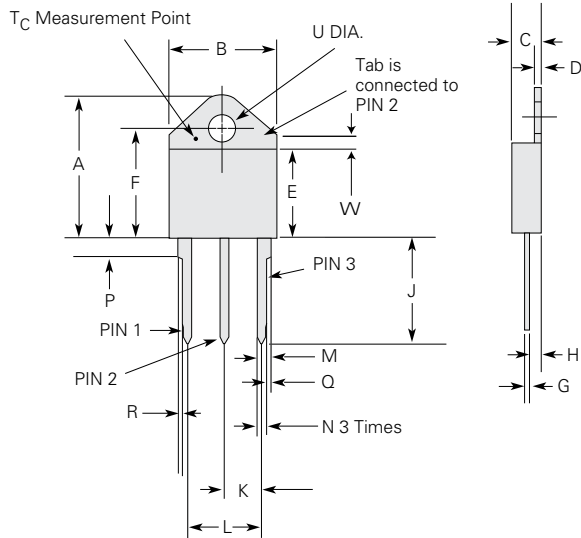

- Notes:**
- Mold flash shall not exceed 0.13 mm per side.
  - Maximum torque to be applied to mounting tab is 8 in-lbs. (0.904 Nm).
  - Pin 3 has no connection.
  - Tab is non-isolated (connects to middle pin).

Dimensions	Inches		Millimeters	
	Min	Max	Min	Max
<b>A</b>	0.810	0.835	20.57	21.21
<b>B</b>	0.610	0.630	15.49	16.00
<b>C</b>	0.178	0.188	4.52	4.78
<b>D</b>	0.055	0.070	1.40	1.78
<b>E</b>	0.487	0.497	12.37	12.62
<b>F</b>	0.635	0.655	16.13	16.64
<b>G</b>	0.022	0.029	0.56	0.74
<b>H</b>	0.075	0.095	1.91	2.41
<b>J</b>	0.575	0.625	14.61	15.88
<b>K</b>	0.211	0.219	5.36	5.56
<b>L</b>	0.422	0.437	10.72	11.10
<b>M</b>	0.058	0.068	1.47	1.73
<b>N</b>	0.045	0.055	1.14	1.40
<b>P</b>	0.095	0.115	2.41	2.92
<b>R</b>	0.008	0.016	0.20	0.41
<b>U</b>	0.161	0.165	4.1	4.2
<b>W</b>	0.085	0.095	2.17	2.42

**Packing Options**

Package Type	Description	Packing Options Quantity	Added Suffix	Industry Standard
M	TO-218 (ME) Tube Pack	250(25 per tube/10 tubes per box)	N/A	N/A

**Tube Pack Specification — TO-218**

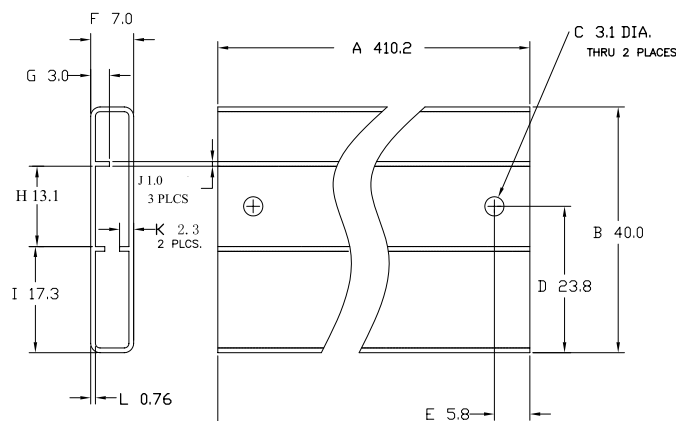

**Disclaimer Notice** - Information furnished is believed to be accurate and reliable. However, users should independently evaluate the suitability of and test each product selected for their own applications. Littelfuse products are not designed for, and may not be used in, all applications. Read complete Disclaimer Notice at <http://www.littelfuse.com/disclaimer-electronics>.